

水槽、壁龛、立柱艺术盆
shion bathroom

since2013



fashion bathroom

since2013

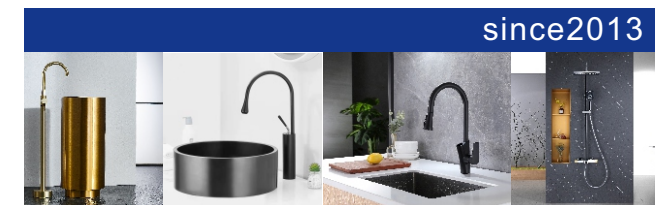

CONTACT USE

mail:info@vincentaa.com

Email:VincentaaSculpture@gmail.com

Website:www.Vincentaa.com

Mobile:+86 183-3313-5888/136-0331-1075

Instagram: @sculpture_supplier

所有资料仅供参考，颜色、尺寸如有差异，请以实物为主。

The style and color of the products shown in this catalogue are for reference and rel products are subject to samples

台上安装

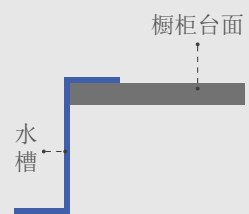

台平安装

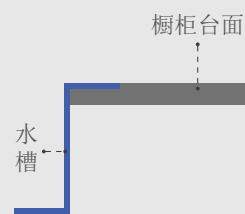

台下安装

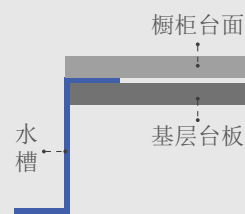

砧板架

采用优质不锈钢制作，人性化设计完美配合水槽，让您的厨房更加便捷轻松

沥水篮

采用不锈钢制作，圆型设计完美配合水槽，让您的厨房更加轻松自然。

水槽

冷拉伸工艺，数控电阻焊，阶梯形缓冲水槽，给空间注入想象，尽善尽美。

厨房龙头

精选铜材龙头，健康无铅，造型精美雅致，彰显品味。

刀筷盒

首创不割手刀筷盒，优质不锈钢材质，贴平水槽表面，不割手，不漏水，居家安全至关重要。

皂液器

超强拉丝表面，与水槽完美结合，不断裂，是您的洁净帮手。

小水盆

SUS 304 材质，圆弧形护手设计，搭配水槽，更节约用水，洗涤更方便。

单盆下水管

塑料黑色下水管，耐脏耐磨，出水无阻。

刀筷盒

首创不割手刀筷盒，优质不锈钢材质，贴平水槽表面，不割手，不漏水，居家安全至关重要。

红木菜板

采用红木制作，长型设计完美配合水槽，让您的厨房更加轻松自然。

水槽

冷拉伸工艺，数控电阻焊，阶梯形缓冲水槽，给空间注入想象，尽善尽美。

厨房龙头

精选铜材龙头，健康无铅，造型精美雅致，彰显品味。

皂液器

超强拉丝表面，与水槽完美结合，不断裂，是您的洁净帮手。

沥水盆

采用不锈钢制作，圆型设计完美配合水槽，让您的厨房更加轻松自然。

双盆下水管

塑料黑色下水管，耐脏耐磨，出水无阻。



LUXURY STAINLESS STEEL SINK

高品质不锈钢水槽 / 壁龛 / 艺术盆

工艺精湛-品质第一



可选配件: 沥水篮 下水器 木菜板 盆中盆 厨房龙头 皂液器

3.0/1.0mm SUS304 不锈钢 / 丝光面 Stainless steel / Satin polished
 安装开孔尺寸 Cutout dimensions: 按实物或开孔纸 Template with actual product

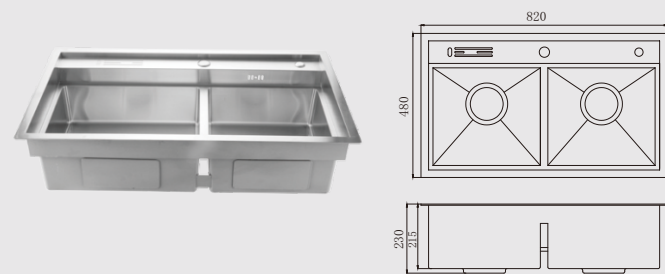

Model: ZP8248ST

水槽尺寸 Dimensions: 820x480x230mm
 开孔尺寸 Cutout dimensions: 790x450mm

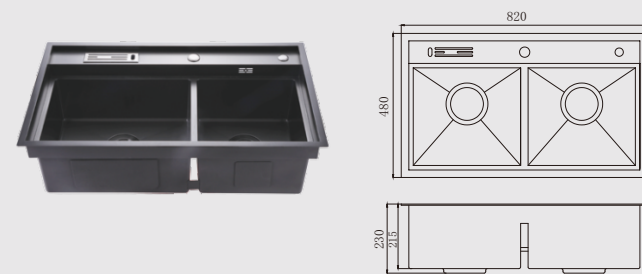

Model: ZP8248STH

水槽尺寸 Dimensions: 820x480x230mm
 开孔尺寸 Cutout dimensions: 790x450mm

可选配件 Accessories:



ZP501H 沥水篮 Drain basket
 ZP502H 小水槽 Small sink
 ZP3002 厨房龙头 Kitchen mixer
 ZP101 砧板 Cutting board
 ZP303 刀架 Knife shelf
 ZP705H 下水头 Strainer
 ZP808H 下水管 Drain pipe
 ZP204H 皂液器 Copper
 ZP01 净水龙头 Pure tap

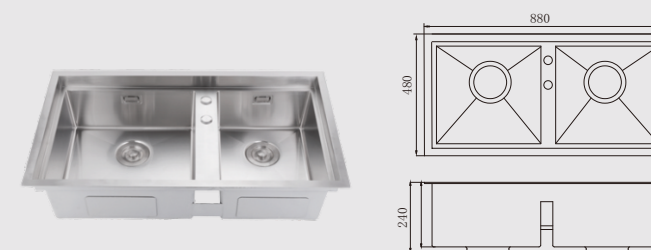

Model: ZP8848ATL

水槽尺寸 Dimensions: 880x480x240mm
 开孔尺寸 Cutout dimensions: 850x450mm

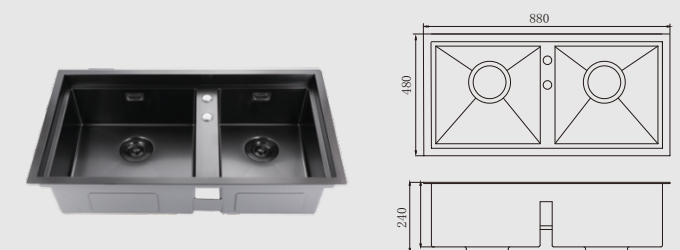

Model: ZP8848ATH

水槽尺寸 Dimensions: 880x480x240mm
 开孔尺寸 Cutout dimensions: 850x450mm

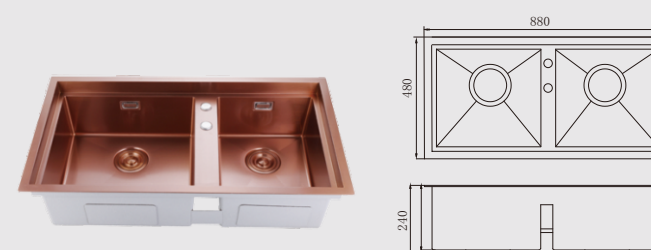

Model: ZP8848ATM

水槽尺寸 Dimensions: 880x480x240mm
 开孔尺寸 Cutout dimensions: 850x450mm

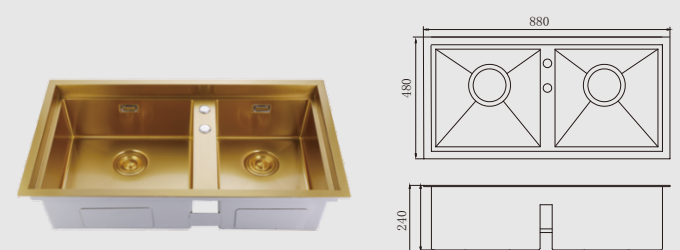

Model: ZP8848ATG

水槽尺寸 Dimensions: 880x480x240mm
 开孔尺寸 Cutout dimensions: 850x450mm



可选配件: 伸缩沥水篮 下水器 木菜板 盆中盆 净水龙头 皂液器

3.0/1.0mm SUS304 不锈钢 / 丝光面 Stainless steel / Satin polished
 安装开孔尺寸 Cutout dimensions: 按实物或开孔纸 Template with actual product

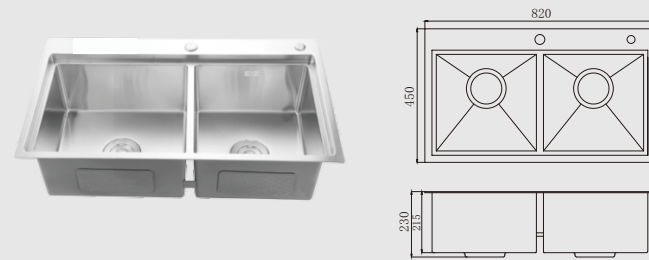

Model: ZP8245ATD

水槽尺寸 Dimensions: 820x450x230mm
 开孔尺寸 Cutout dimensions: 790x420mm

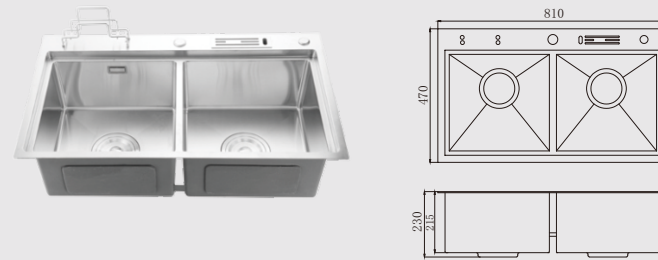

Model: ZP8147ATD

水槽尺寸 Dimensions: 810x470x230mm
 开孔尺寸 Cutout dimensions: 780x440mm

可选配件 Accessories:



ZP605 伸缩沥水篮 Drain basket
 ZP502 小水槽 Small sink
 ZP3001 厨房龙头 Kitchen mixer
 ZP101 砧板 Cutting board
 ZP303 刀架 Knife shelf
 ZP705 下水头 Strainer
 ZP808 下水管 Drain pipe
 ZP204 皂液器 Copper
 ZP01 净水龙头 Pure tap

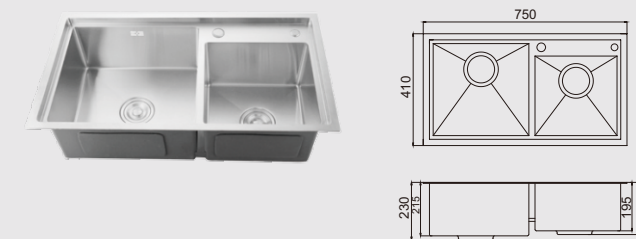

Model: ZP7541AT

水槽尺寸 Dimensions: 750x410x230mm
 开孔尺寸 Cutout dimensions: 720x380mm

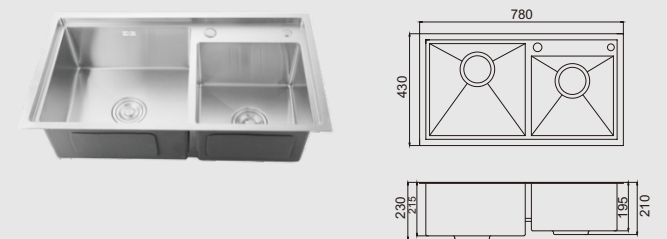

Model: ZP7843AT

水槽尺寸 Dimensions: 780x430x230mm
 开孔尺寸 Cutout dimensions: 750x400mm

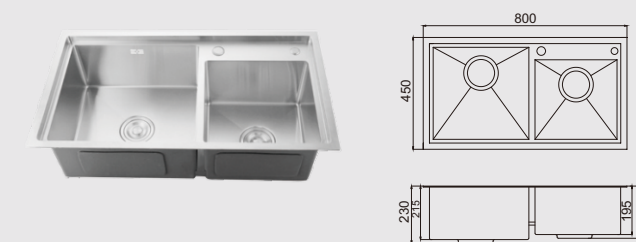

Model: ZP8045AT

水槽尺寸 Dimensions: 800x450x230mm
 开孔尺寸 Cutout dimensions: 770x420mm

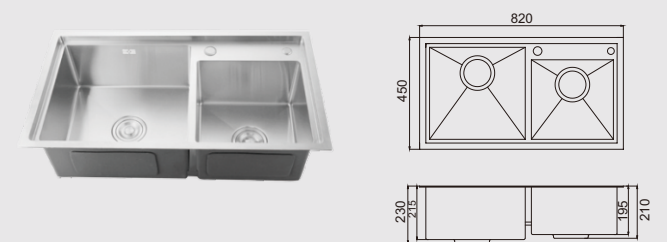

Model: ZP8245AT

水槽尺寸 Dimensions: 820x450x230mm
 开孔尺寸 Cutout dimensions: 790x420mm

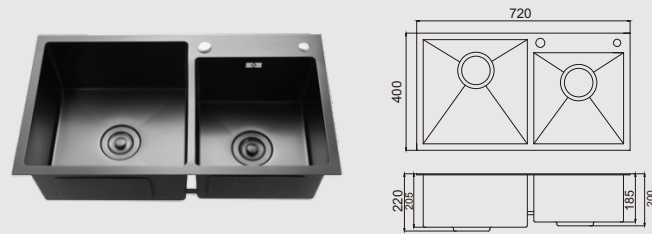

Model: ZP7240WH

水槽尺寸 Dimensions: 720x400x220mm
开孔尺寸 Cutout dimensions: 690x370mm

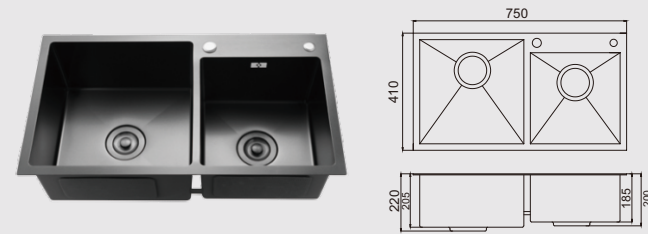

Model: ZP7541WH

水槽尺寸 Dimensions: 750x410x220mm
开孔尺寸 Cutout dimensions: 720x380mm

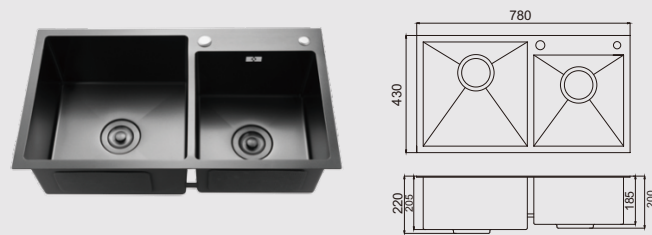

Model: ZP7843WH

水槽尺寸 Dimensions: 780x430x220mm
开孔尺寸 Cutout dimensions: 750x400mm

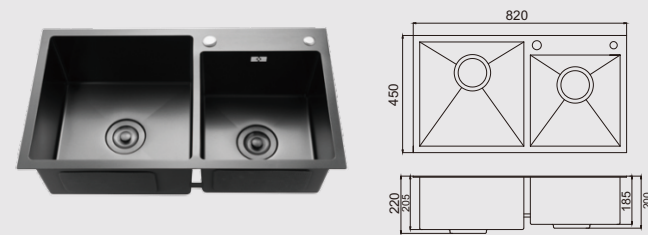

Model: ZP8245WH

水槽尺寸 Dimensions: 820x450x220mm
开孔尺寸 Cutout dimensions: 790x420mm

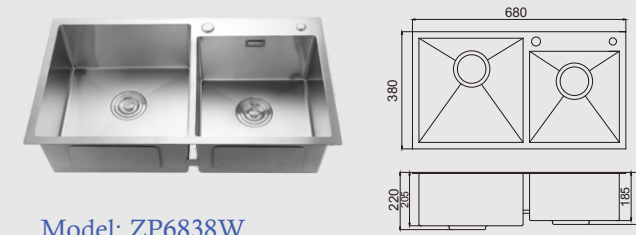

Model: ZP6838W

水槽尺寸 Dimensions: 680x380x220mm
开孔尺寸 Cutout dimensions: 650x350mm

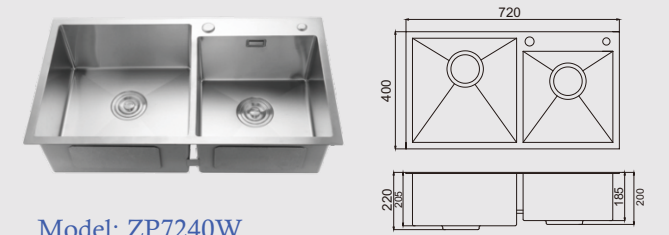

Model: ZP7240W

水槽尺寸 Dimensions: 720x400x220mm
开孔尺寸 Cutout dimensions: 690x370mm

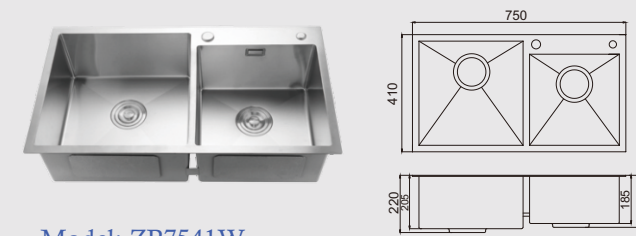

Model: ZP7541W

水槽尺寸 Dimensions: 750x410x220mm
开孔尺寸 Cutout dimensions: 720x380mm

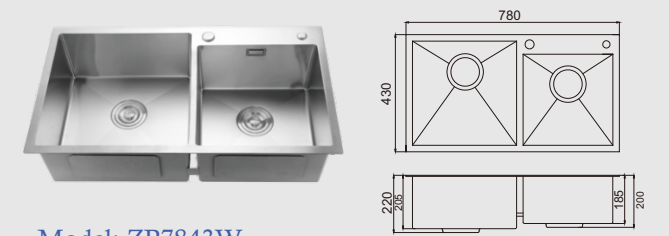

Model: ZP7843W

水槽尺寸 Dimensions: 780x430x220mm
开孔尺寸 Cutout dimensions: 750x400mm

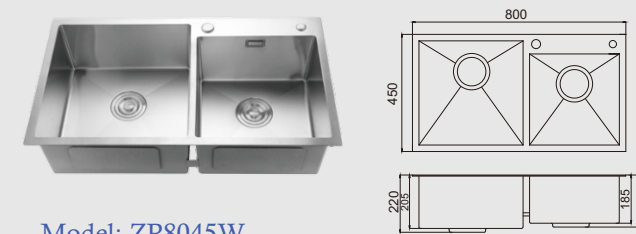

Model: ZP8045W

水槽尺寸 Dimensions: 800x450x220mm
开孔尺寸 Cutout dimensions: 770x420mm

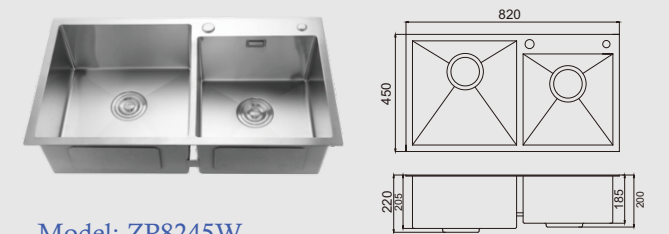

Model: ZP8245W

水槽尺寸 Dimensions: 820x450x220mm
开孔尺寸 Cutout dimensions: 790x420mm



可选配件：沥水篮 下水器 木菜板 盆中盆 厨房龙头 皂液器



可选配件：伸缩沥水篮 下水器 木菜板 盆中盆 净水龙头 皂液器

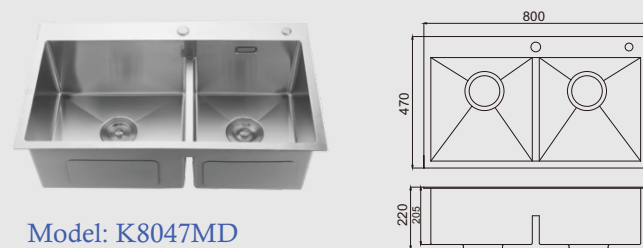

Model: K8047MD

水槽尺寸 Dimensions: 800x470x220mm
开孔尺寸 Cutout dimensions: 770x440mm

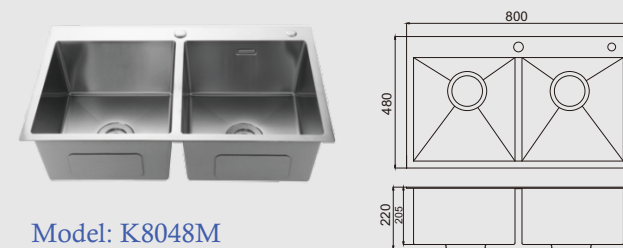

Model: K8048M

水槽尺寸 Dimensions: 800x480x220mm
开孔尺寸 Cutout dimensions: 770x450mm

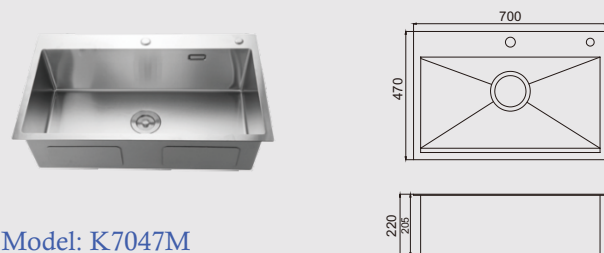

Model: K7047M

水槽尺寸 Dimensions: 700x470x220mm
开孔尺寸 Cutout dimensions: 670x440mm

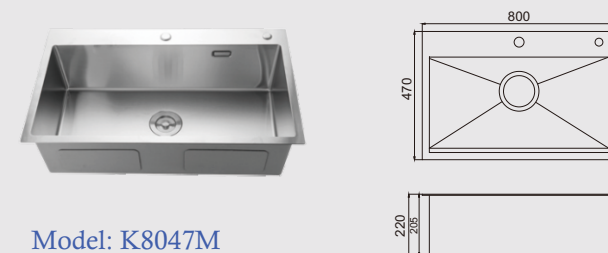

Model: K8047M

水槽尺寸 Dimensions: 800x470x220mm
开孔尺寸 Cutout dimensions: 770x440mm

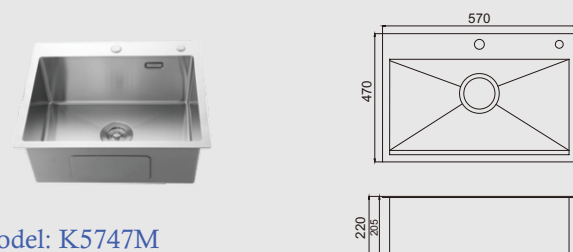

Model: K5747M

水槽尺寸 Dimensions: 570x470x220mm
开孔尺寸 Cutout dimensions: 540x440mm

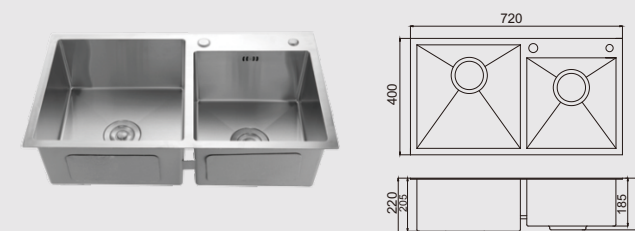

Model: ZP7240B

水槽尺寸 Dimensions: 720x400x220mm
开孔尺寸 Cutout dimensions: 690x370mm

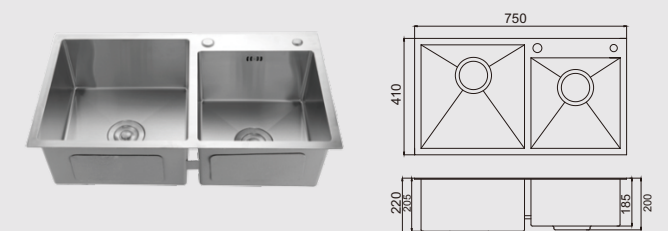

Model: ZP7541B

水槽尺寸 Dimensions: 750x410x220mm
开孔尺寸 Cutout dimensions: 720x380mm

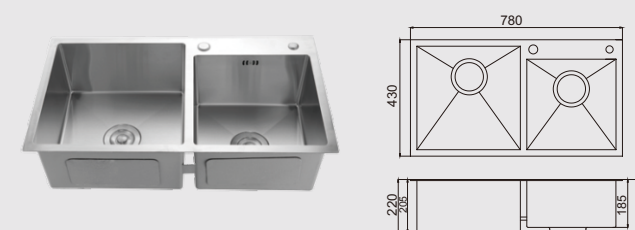

Model: ZP7843B

水槽尺寸 Dimensions: 780x430x220mm
开孔尺寸 Cutout dimensions: 750x400mm

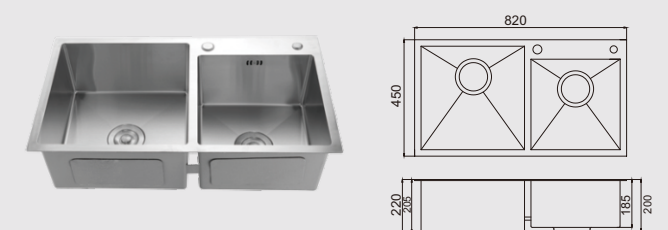

Model: ZP8245B

水槽尺寸 Dimensions: 820x450x220mm
开孔尺寸 Cutout dimensions: 790x420mm

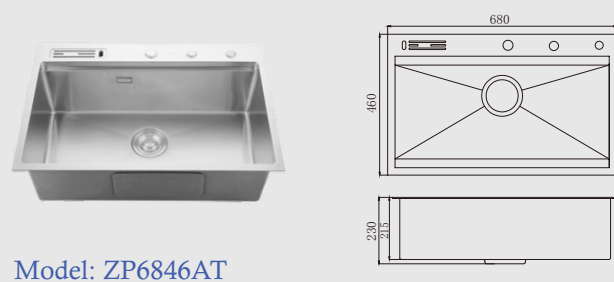

Model: ZP6846AT

水槽尺寸 Dimensions: 680x460x230mm
开孔尺寸 Cutout dimensions: 650x430mm

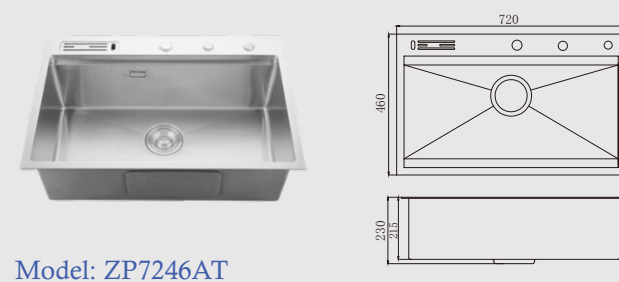

Model: ZP7246AT

水槽尺寸 Dimensions: 720x460x230mm
开孔尺寸 Cutout dimensions: 690x430mm

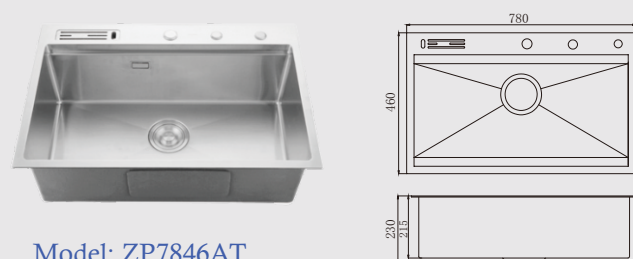

Model: ZP7846AT

水槽尺寸 Dimensions: 780x460x230mm
开孔尺寸 Cutout dimensions: 750x430mm

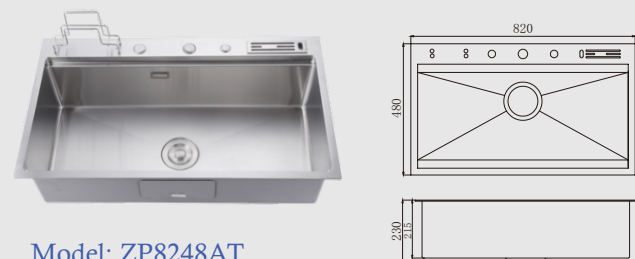

Model: ZP8248AT

水槽尺寸 Dimensions: 820x480x230mm
开孔尺寸 Cutout dimensions: 790x450mm

可选配件 Accessories:



ZP501 沥水篮 Drain basket
ZP502 小水槽 Small sink
ZP3001 厨房龙头 Kitchen mixer
ZP101 砧板 Cutting board
ZP303 刀架 Knife shelf
ZP705 下水头 Strainer
ZP805 下水管 Drain pipe
ZP204 皂液器 Copper
ZP01 净水龙头 Pure tap

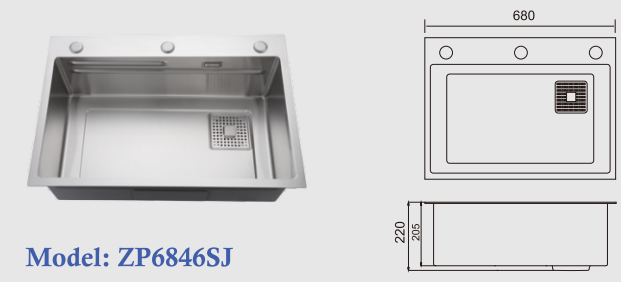

Model: ZP6846SJ

水槽尺寸 Dimensions: 680x460x220mm
开孔尺寸 Cutout dimensions: 650x430mm



Model: ZP7546SJ

水槽尺寸 Dimensions: 750x460x220mm
开孔尺寸 Cutout dimensions: 720x430mm

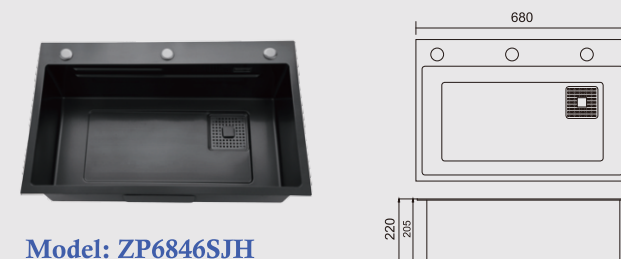

Model: ZP6846SJH

水槽尺寸 Dimensions: 680x460x220mm
开孔尺寸 Cutout dimensions: 650x430mm

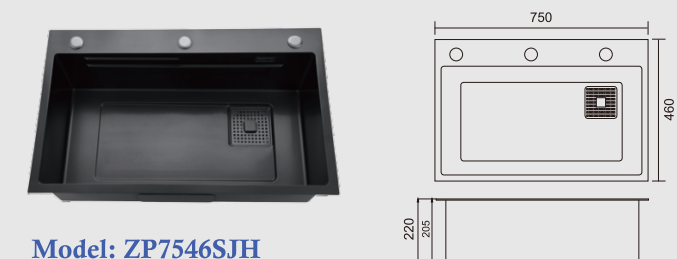

Model: ZP7546SJH

水槽尺寸 Dimensions: 750x460x220mm
开孔尺寸 Cutout dimensions: 720x430mm

可选配件 Accessories:



ZP501 沥水篮 Drain basket
ZP502 小水槽 Small sink
ZP3006 厨房龙头 Kitchen mixer
ZP101 砧板 Cutting board
ZP705 下水头 Strainer
ZP805 下水管 Drain pipe
ZP204 皂液器 Copper
ZP01 净水龙头 Pure tap
ZP102 洗杯器 Glass rinser



可选配件: 伸缩沥水篮 下水器 木菜板 盆中盆 净水龙头 皂液器



可选配件: 伸缩沥水篮 下水器 木菜板 盆中盆 净水龙头 皂液器

<p>Model: ZP5040MH 水槽尺寸 Dimensions: 500x400x220mm 开孔尺寸 Cutout dimensions: 470x370mm</p>	<p>Model: ZP5545MH 水槽尺寸 Dimensions: 550x450x220mm 开孔尺寸 Cutout dimensions: 520x420mm</p>
<p>Model: ZP6045MH 水槽尺寸 Dimensions: 600x450x220mm 开孔尺寸 Cutout dimensions: 570x420mm</p>	<p>Model: ZP6845MH 水槽尺寸 Dimensions: 680x450x220mm 开孔尺寸 Cutout dimensions: 650x420mm</p>
<p>Model: ZP7545MH 水槽尺寸 Dimensions: 750x450x220mm 开孔尺寸 Cutout dimensions: 720x420mm</p>	<p>Model: ZP7848MH 水槽尺寸 Dimensions: 780x480x220mm 开孔尺寸 Cutout dimensions: 750x450mm</p>

<p>Model: ZP5040M 水槽尺寸 Dimensions: 500x400x220mm 开孔尺寸 Cutout dimensions: 470x370mm</p>	<p>Model: ZP5545M 水槽尺寸 Dimensions: 550x450x220mm 开孔尺寸 Cutout dimensions: 520x420mm</p>
<p>Model: ZP5843M 水槽尺寸 Dimensions: 580x430x220mm 开孔尺寸 Cutout dimensions: 550x400mm</p>	<p>Model: ZP6045M 水槽尺寸 Dimensions: 600x450x220mm 开孔尺寸 Cutout dimensions: 570x420mm</p>
<p>Model: ZP6545M 水槽尺寸 Dimensions: 650x450x220mm 开孔尺寸 Cutout dimensions: 620x420mm</p>	<p>Model: ZP6845M 水槽尺寸 Dimensions: 680x450x220mm 开孔尺寸 Cutout dimensions: 650x420mm</p>
<p>Model: ZP7545M 水槽尺寸 Dimensions: 750x450x220mm 开孔尺寸 Cutout dimensions: 720x420mm</p>	<p>Model: ZP7848M 水槽尺寸 Dimensions: 780x480x220mm 开孔尺寸 Cutout dimensions: 750x450mm</p>

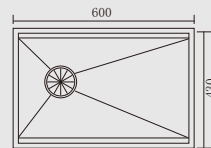

Model: ZP6043XT

水槽尺寸 Dimensions: 600x430x220mm
开孔尺寸 Cutout dimensions: 570x400mm

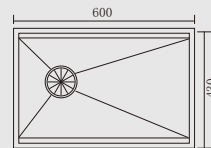

Model: ZP6043XTH

水槽尺寸 Dimensions: 600x430x220mm
开孔尺寸 Cutout dimensions: 570x400mm

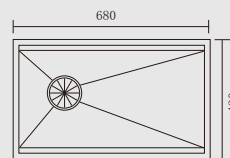

Model: ZP6843XT

水槽尺寸 Dimensions: 680x430x220mm
开孔尺寸 Cutout dimensions: 650x400mm

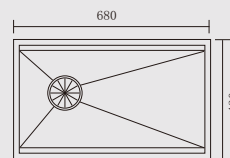

Model: ZP6843XTH

水槽尺寸 Dimensions: 680x430x220mm
开孔尺寸 Cutout dimensions: 650x400mm

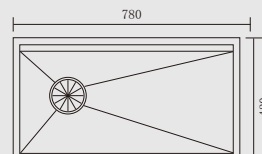

Model: ZP7843XT

水槽尺寸 Dimensions: 780x430x220mm
开孔尺寸 Cutout dimensions: 750x400mm

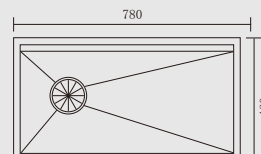

Model: ZP7843XTH

水槽尺寸 Dimensions: 780x430x220mm
开孔尺寸 Cutout dimensions: 750x400mm

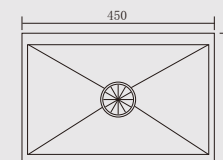

Model: ZP4540X

水槽尺寸 Dimensions: 450x400x220mm
开孔尺寸 Cutout dimensions: 420x370mm

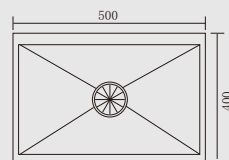

Model: ZP5040X

水槽尺寸 Dimensions: 500x400x220mm
开孔尺寸 Cutout dimensions: 470x370mm

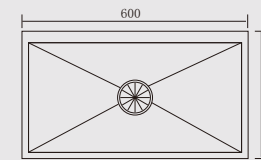

Model: ZP6045X

水槽尺寸 Dimensions: 600x450x220mm
开孔尺寸 Cutout dimensions: 570x420mm

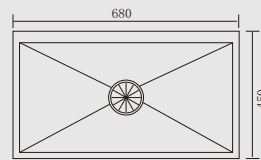

Model: ZP6845X

水槽尺寸 Dimensions: 680x450x220mm
开孔尺寸 Cutout dimensions: 650x420mm

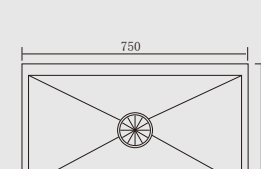

Model: ZP7545X

水槽尺寸 Dimensions: 750x450x220mm
开孔尺寸 Cutout dimensions: 720x420mm

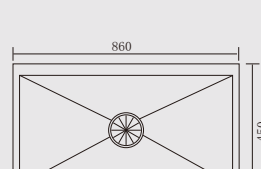

Model: ZP8645X

水槽尺寸 Dimensions: 860x450x220mm
开孔尺寸 Cutout dimensions: 830x420mm





可选配件： 滤 网 盆 盖 架

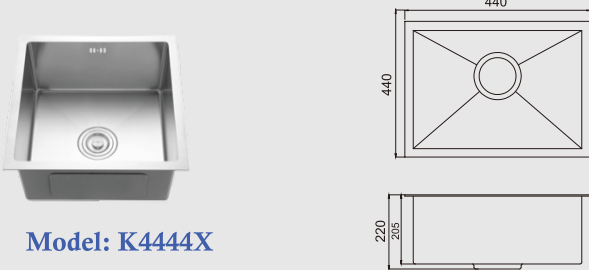
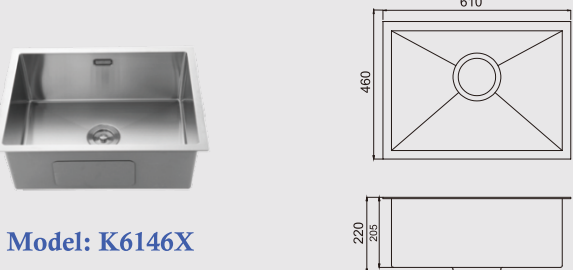
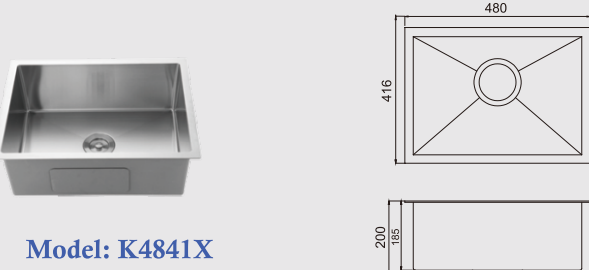
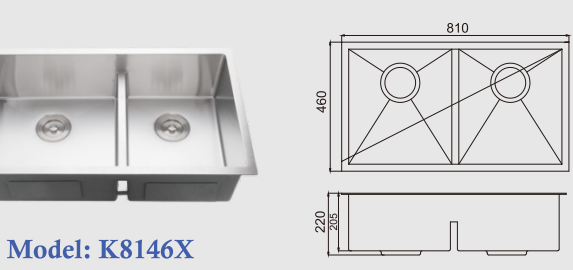
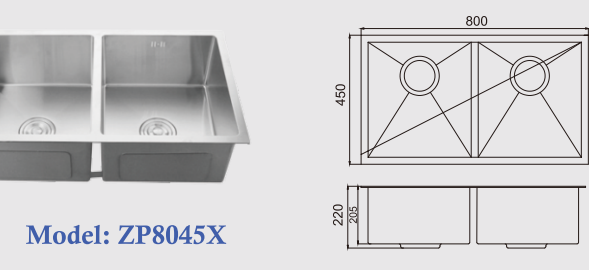
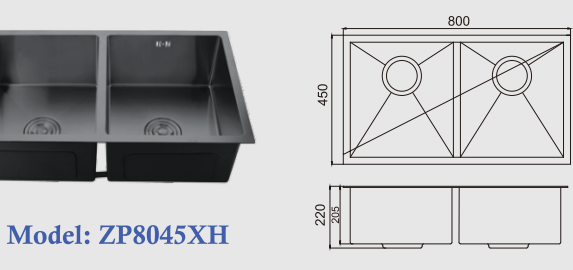

可选配件： 沥水篮 下水器 木质砧板 盆中盆 净水龙头 皂液器

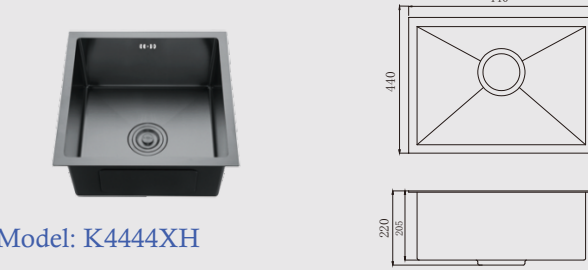
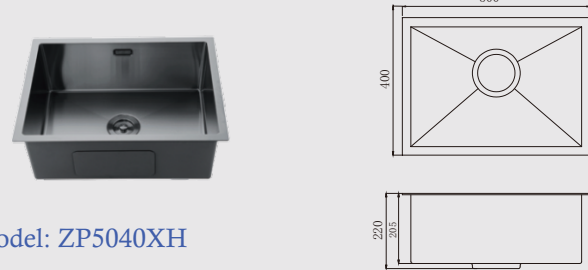
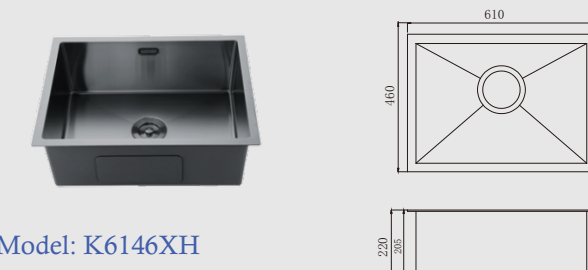
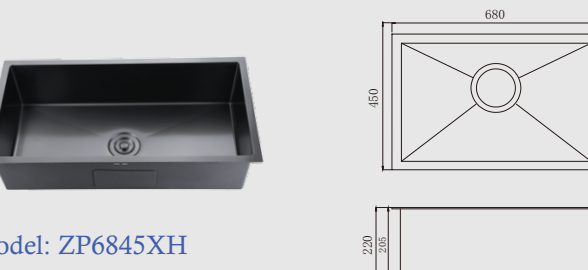
 <p>Model: K4444X 水槽尺寸 Dimensions: 440x440x220mm 开孔尺寸 Cutout dimensions: 410x410mm</p>	 <p>Model: K6146X 水槽尺寸 Dimensions: 610x460x220mm 开孔尺寸 Cutout dimensions: 580x430mm</p>
 <p>Model: K4841X 水槽尺寸 Dimensions: 480x416x200mm 开孔尺寸 Cutout dimensions: 440x370mm</p>	 <p>Model: K8146X 水槽尺寸 Dimensions: 810x460x220mm 开孔尺寸 Cutout dimensions: 780x430mm</p>
 <p>Model: ZP8045X 水槽尺寸 Dimensions: 800x450x220mm 开孔尺寸 Cutout dimensions: 770x420mm</p>	 <p>Model: ZP8045XH 水槽尺寸 Dimensions: 800x450x220mm 开孔尺寸 Cutout dimensions: 770x420mm</p>

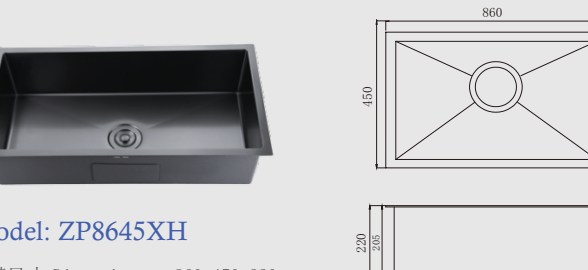
 <p>Model: K4444XH 水槽尺寸 Dimensions: 440x440x220mm 开孔尺寸 Cutout dimensions: 410x410mm</p>	 <p>Model: ZP5040XH 水槽尺寸 Dimensions: 500x400x220mm 开孔尺寸 Cutout dimensions: 470x370mm</p>
 <p>Model: K6146XH 水槽尺寸 Dimensions: 610x460x220mm 开孔尺寸 Cutout dimensions: 580x430mm</p>	 <p>Model: ZP6845XH 水槽尺寸 Dimensions: 680x450x220mm 开孔尺寸 Cutout dimensions: 650x420mm</p>
 <p>Model: ZP7545XH 水槽尺寸 Dimensions: 750x450x220mm 开孔尺寸 Cutout dimensions: 720x420mm</p>	 <p>Model: ZP8645XH 水槽尺寸 Dimensions: 860x450x220mm 开孔尺寸 Cutout dimensions: 830x420mm</p>



304 不锈钢网红款系列



型号: **ZP6845DH**
规格: 680x450x220mm
开孔尺寸: 650x420mm

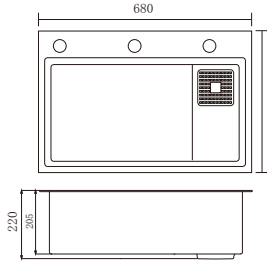

型号: **ZP7545DH**
规格: 750x450x220mm
开孔尺寸: 720x420mm

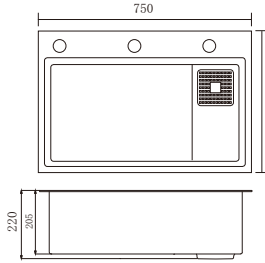

可选配件:



不锈钢网红款飞雨系列

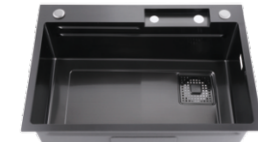

型号: **ZP6846FYH**
规格: 680x460x220mm
开孔尺寸: 650x430mm

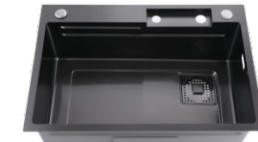
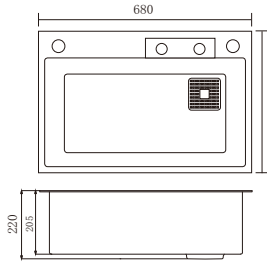

型号: **ZP7546FYH**
规格: 750x460x220mm
开孔尺寸: 720x430mm

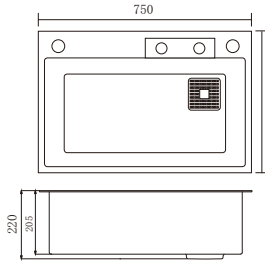

可选配件:



日式系列



型号: **ZP7848DW (压纹)**
规格: 780x480x230mm
开孔尺寸: 750x450mm

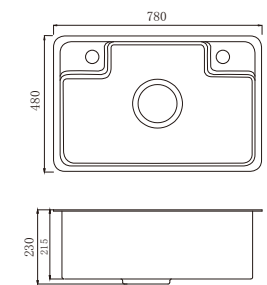

型号: **ZP7848DH**
规格: 780x480x230mm
开孔尺寸: 750x450mm

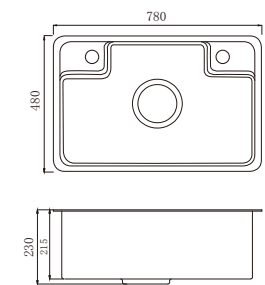

可选配件:

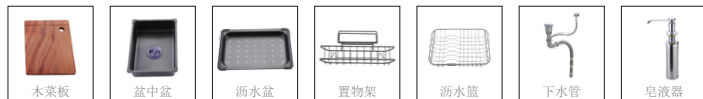

型号: **ZP8143QX**
规格: 810x430x220mm
开孔尺寸: 780x400mm

可选配件:



特价款拉伸盆系列



型号: **ZP6838QX**
规格: 680x380x220mm
开孔尺寸: 650x350mm



型号: **ZP7540QX**
规格: 750x400x220mm
开孔尺寸: 720x370mm



型号: **ZP7339QX**
规格: 730x390x220mm
开孔尺寸: 700x360mm



型号: **ZP7843QX**
规格: 780x430x220mm
开孔尺寸: 750x400mm



热销款拉伸盆系列



型号: **ZP6839HR**
规格: 680x390x220mm
开孔尺寸: 650x360mm



型号: **ZP7541HR**
规格: 750x410x220mm
开孔尺寸: 720x380mm



型号: **ZP7241HR**
规格: 720x410x220mm
开孔尺寸: 690x380mm



型号: **ZP7642HR**
规格: 760x420x220mm
开孔尺寸: 730x390mm

可选配件:



型号: **ZP7843HR**
规格: 780x430x220mm
开孔尺寸: 750x400mm



型号: **ZP8245HR**
规格: 820x450x220mm
开孔尺寸: 790x420mm



型号: **ZP8143HR**
规格: 810x430x220mm
开孔尺寸: 780x400mm



型号: **ZP9243HR**
规格: 920x430x220mm
开孔尺寸: 890x400mm

可选配件:



台下盆黑金刚纳米系列



型号: ZP3533YH
规格: 350x330x210mm
开孔尺寸: 320x300mm

型号: ZP4236YH
规格: 420x360x210mm
开孔尺寸: 390x330mm

型号: ZP4540YH
规格: 450x400x220mm
开孔尺寸: 420x370mm

型号: ZP36YH
规格: 360x210mm
开孔尺寸: 330mm

型号: ZP40YH
规格: 400x210mm
开孔尺寸: 370mm

台下盆系列



型号: ZP3330Y
规格: 330x300x210mm
开孔尺寸: 300x270mm

型号: ZP4236Y
规格: 420x360x210mm
开孔尺寸: 390x330mm

型号: ZP4540Y
规格: 450x400x220mm
开孔尺寸: 420x370mm

型号: ZP36Y
规格: 360x210mm
开孔尺寸: 330mm

型号: ZP40Y
规格: 400x210mm
开孔尺寸: 370mm

台平盆系列



型号: ZP3833H
规格: 380x330x210mm
开孔尺寸: 350x300mm

型号: ZP4236P
规格: 420x360x210mm
开孔尺寸: 390x330mm

型号: ZP4236H
规格: 420x360x210mm
开孔尺寸: 390x330mm

型号: ZP4237H
规格: 420x370x210mm
开孔尺寸: 390x340mm

型号: ZP4238H
规格: 420x380x210mm
开孔尺寸: 390x350mm



型号: ZP4835H
规格: 480x350x210mm
开孔尺寸: 450x320mm

型号: ZP4539H
规格: 450x390x210mm
开孔尺寸: 420x360mm

型号: ZP5040H
规格: 500x400x210mm
开孔尺寸: 470x370mm

型号: ZP5238H
规格: 520x380x210mm
开孔尺寸: 490x350mm

型号: ZP6045H
规格: 600x450x220mm
开孔尺寸: 570x420mm



型号: ZP5843H
规格: 580x430x220mm
开孔尺寸: 550x400mm

型号: ZP6245H
规格: 620x450x220mm
开孔尺寸: 590x420mm

型号: ZP6844H
规格: 680x440x220mm
开孔尺寸: 650x410mm

型号: ZP6845HR
规格: 680x450x220mm
开孔尺寸: 650x420mm

型号: ZP7545H
规格: 750x450x220mm
开孔尺寸: 720x420mm

水槽配件系列



型号: ZP101
品名: 红木菜板

型号: ZP102
品名: 洗杯器

型号: ZP203QH
品名: 皂液器

型号: ZP201
品名: 皂液器

型号: ZP201H
品名: 皂液器

型号: ZP204
品名: 皂液器

型号: ZP701
品名: 下水头

型号: ZP705
品名: 下水头



型号: ZP501
品名: 沥水盆

型号: ZP502
品名: 盆中盆

型号: ZP502H
品名: 盆中盆

型号: SC601
品名: 沥水篮

型号: ZP603
品名: 沥水篮

型号: ZP605
品名: 伸缩沥水篮

型号: ZP605H
品名: 伸缩沥水篮

型号: ZP503
品名: 卷帘



型号: ZP801
品名: 单盆 40管

型号: ZP802
品名: 单盆 40管

型号: ZP803
品名: 双盆 40管

型号: ZP806
品名: 双盆 50管

型号: ZP805
品名: 单盆 50管

型号: ZP807
品名: 单盆 50管

型号: ZP808
品名: 双盆 50管

型号: ZP809
品名: 单盆 50管

型号: ZP810
品名: 双盆 50管



型号: ZP3101
厨房龙头 (铬色)
Kitchen mixer

型号: ZP3101QH
厨房龙头 (枪灰)
Kitchen mixer

型号: ZP3102
厨房龙头 (铬色)
Kitchen mixer

型号: ZP3103
厨房龙头 (铬色)
Kitchen mixer

型号: ZP32118
厨房龙头 (铬色)
Kitchen mixer

型号: ZP32118H
厨房龙头 (黑色)
Kitchen mixer



型号: ZP3001
厨房龙头 (铬色)
Kitchen mixer

型号: ZP3001QH
厨房龙头 (枪灰)
Kitchen mixer

型号: ZP3001H
厨房龙头 (黑色)
Kitchen mixer

型号: ZP3006
厨房龙头 (铬色)
Kitchen mixer

型号: ZP3006QH
厨房龙头 (枪灰)
Kitchen mixer

型号: ZP3006H
厨房龙头 (黑色)
Kitchen mixer



型号: ZP3002
厨房龙头 (铬色)
Kitchen mixer

型号: ZP3002QH
厨房龙头 (枪灰)
Kitchen mixer

型号: ZP3005
厨房龙头 (铬色)
Kitchen mixer

型号: ZP3005QH
厨房龙头 (枪灰)
Kitchen mixer

型号: ZP3003
厨房龙头 (铬色)
Kitchen mixer

型号: ZP3003QH
厨房龙头 (枪灰)
Kitchen mixer

智能壁龛



感受真实魅力
从书房到卧室、从玄关到客厅
百搭，无所不搭
多种颜色、惊艳之选

FEEL THE REAL CHARM FROM
STUDY TO BEDROOM, FROM PORCH TO LIVING ROOM
GO WITH EVERYTHING
A VARIETY OF COLORS, AMAZING CHOICE

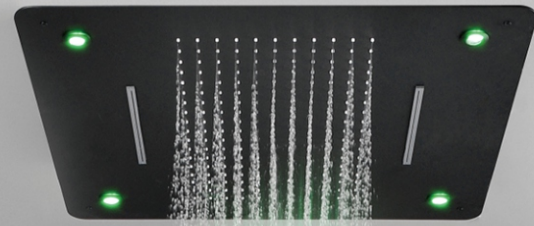

带灯智能壁龛系列
EMBEDDED NICHE SERIES



ZP-3030DDH

名称：单格带灯置物壁龛
产品尺寸：305x305x120mm
开孔尺寸：290x290x120mm
表面处理：拉丝枪黑

Description: Single Layer Niches
Product Size: 305x305x120mm
Opening Size: 290x290x120mm
Finishing: Brushed gun black



ZP-6130SDH

名称：双格带灯置物壁龛
产品尺寸：610x305x120mm
开孔尺寸：595x290x120mm
表面处理：拉丝枪黑

Description: Double Deck Niches
Product Size: 610x305x120mm
Opening Size: 595x290x120mm
Finishing: Brushed gun black



ZP-12130SDH

名称：三格带灯置物壁龛
产品尺寸：1210x305x120mm
开孔尺寸：1195x290x120mm
表面处理：拉丝枪黑

Description: Three Storeyed Niches
Product Size: 1210x305x120mm
Opening Size: 1195x290x120mm
Finishing: Brushed gun black



ZP-11030SDH

名称：双格带板置物壁龛
产品尺寸：1100x305x120mm
开孔尺寸：1085x290x120mm
表面处理：拉丝枪黑

Description: Double Deck Niches
Product Size: 1100x305x120mm
Opening Size: 1085x290x120mm
Finishing: Brushed gun black

单层置物

于一方天地中，静等一株植物生长
或三碗两盏、盛看杯中岁月
装得下浪漫，也放得住生活
更多颜色，随心挑选

SINGLE LAYER PROPERTY
IN ONE WORLD, A PLANT GROWS LIKE STATIC
OR THREE BOWLS, TWO, AND THE YEARS IN THE CUP
ROMANTIC AND LIFE
MORE COLORS, CHOOSE FROM YOUR HEART



30 单格壁龛系列
EMBEDDED NICHE SERIES



ZP-3030DL

名称：单格置物壁龛
产品尺寸：305x305x120mm
开孔尺寸：290x290x120mm
表面处理：拉丝

Description: Single Layer Niches
Product Size: 305x305x120mm
Opening Size: 290x290x120mm
Finishing: Brushed nickel



ZP-3030DH

名称：单格置物壁龛
产品尺寸：305x305x120mm
开孔尺寸：290x290x120mm
表面处理：拉丝枪黑

Description: Single Layer Niches
Product Size: 305x305x120mm
Opening Size: 290x290x120mm
Finishing: Brushed gun black



ZP-3030DG

名称：单格置物壁龛
产品尺寸：305x305x120mm
开孔尺寸：290x290x120mm
表面处理：拉丝金

Description: Single Layer Niches
Product Size: 305x305x120mm
Opening Size: 290x290x120mm
Finishing: Brushed gold



ZP-3030DM

名称：单格置物壁龛
产品尺寸：305x305x120mm
开孔尺寸：290x290x120mm
表面处理：拉丝玫瑰金

Description: Single Layer Niches
Product Size: 305x305x120mm
Opening Size: 290x290x120mm
Finishing: Brushed rose gold

产品尺寸图：

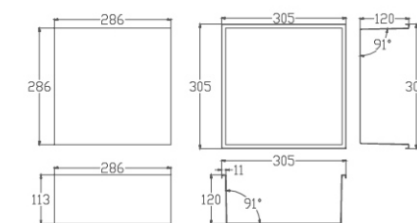



感受真实魅力
从书房到卧室、从玄关到客厅
百搭，无所不搭
多种颜色、惊艳之选

FEEL THE REAL CHARM FROM
STUDY TO BEDROOM, FROM PORCH TO LIVING ROOM
GO WITH EVERYTHING
A VARIETY OF COLORS, AMAZING CHOICE



ZP-6130SH

名称：双格置物壁龛
产品尺寸：610x305x120mm
开孔尺寸：595x290x120mm
表面处理：拉丝枪黑

Description: Double Deck Niches
Product Size: 610x305x120mm
Opening Size: 595x290x120mm
Finishing: Brushed gun black



ZP-6130SG

名称：双格置物壁龛
产品尺寸：610x305x120mm
开孔尺寸：595x290x120mm
表面处理：拉丝金

Description: Double Deck Niches
Product Size: 610x305x120mm
Opening Size: 595x290x120mm
Finishing: Brushed gold

产品尺寸图：

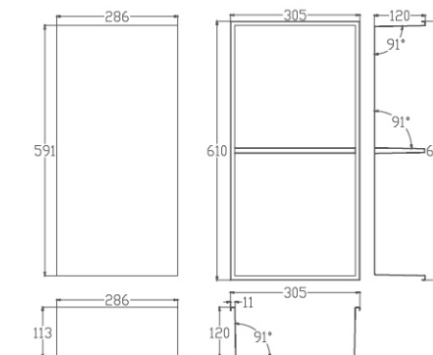

ZP-6130SM

名称：双格置物壁龛
产品尺寸：610x305x120mm
开孔尺寸：595x290x120mm
表面处理：拉丝玫瑰金

Description: Double Deck Niches
Product Size: 610x305x120mm
Opening Size: 595x290x120mm
Finishing: Brushed rose gold



拉丝



拉丝金



拉丝玫瑰金



枪黑

CAIGEN BATHROOM HARDWARE

enable you relaxing bathing and brings you a
happy life. Simple, sanitary, good life.

一行是迷情玫瑰的浪漫
 一行是烟火气息的日常
 一行是悠闲相度的乐趣
 三行情书、多种颜色，盛放更多所需

One line is the romance of infatuated rose
 One line is the daily breath of fireworks
 A party is the pleasure of leisure
 Three lines of love letters, a variety of colors, blooming more



ZP-12130H

三层置物壁龛
 规格：宽:30.5cm 高:121cm 深:12cm
 材质：304不锈钢 1.2mm壁厚
 颜色：黑色
 表面处理：PVC无指纹处理
 开孔尺寸：29*119.5*12cm

Three Storeyed Niches
 Specification: Width:30.5cm Height:121cm Depth:12cm
 Material:304 Stainless Steel 1.2mm Wall Thickness
 Colour: Black
 Surface Treatment: PVD No Fingerprint Processing
 Opening Size: 29*119.5*12cm



ZP-12130T

三层置物壁龛
 规格：宽:30.5cm 高:121cm 深:12cm
 材质：304不锈钢 1.2mm壁厚
 颜色：拉丝金
 表面处理：PVC无指纹处理
 开孔尺寸：29*119.5*12cm

Three Storeyed Niches
 Specification: Width:30.5cm Height:121cm Depth:12cm
 Material:304 Stainless Steel 1.2mm Wall Thickness
 Colour: Golden Drawbench
 Surface Treatment: PVD No Fingerprint Processing
 Opening Size: 29*119.5*12cm



ZP-12130M

三层置物壁龛
 规格：宽:30.5cm 高:121cm 深:12cm
 材质：304不锈钢 1.2mm壁厚
 颜色：玫瑰金
 表面处理：PVC无指纹处理
 开孔尺寸：29*119.5*12cm

Three Storeyed Niches
 Specification: Width:30.5cm Height:121cm Depth:12cm
 Material:304 Stainless Steel 1.2mm Wall Thickness
 Colour: Gun Gray
 Surface Treatment: PVD No Fingerprint Processing
 Opening Size: 29*119.5*12cm

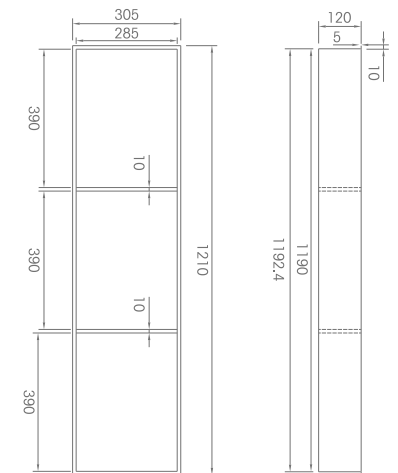



以实用诠释不将就
多元化功能让每一处小心思都更有爱
多种颜色，选你所想

PRACTICAL INTERPRETATION
DIVERSIFIED FUNCTIONS MAKE EVERY PLACE MORE LOVING
MANY COLORS, CHOOSE WHAT YOU WANT



ZP-11030H2

三层带门置物壁龛
规格: 宽:30.5cm 高:110cm 深:12cm
材质: 304不锈钢 1.2mm壁厚
颜色: 黑色
表面处理: PVC无指纹处理
开孔尺寸: 29.5*108.5*12cm

Three Level Niches With Doors
Specification: Width:30.5cm Height:110cm Depth:12cm
Material:304 Stainless Steel 1.2mm Wall Thickness
Colour: Black
Surface Treatment: PVD No Fingerprint Processing
Opening Size: 29.5*108.5*12cm

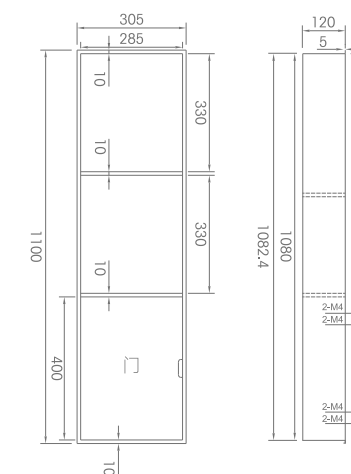

ZP-11030T2

三层带门置物壁龛
规格: 宽:30.5cm 高:110cm 深:12cm
材质: 304不锈钢 1.2mm壁厚
颜色: 拉丝金
表面处理: PVC无指纹处理
开孔尺寸: 29.5*108.5*12cm

Three Level Niches With Doors
Specification: Width:30.5cm Height:110cm Depth:12cm
Material:304 Stainless Steel 1.2mm Wall Thickness
Colour: Golden Drawbench
Surface Treatment: PVD No Fingerprint Processing
Opening Size: 29.5*108.5*12cm

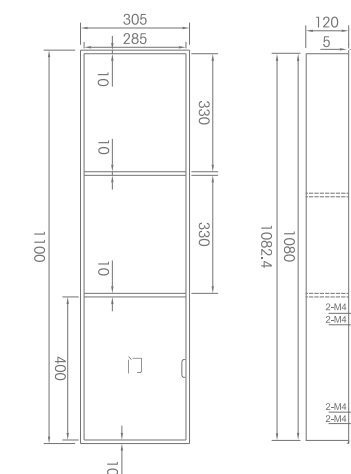

为你节省空间、创造空间
洞见每一种精臻享受
不锈钢用料、现代化工艺、多种百搭配色

SAVE SPACE AND CREATE SPACE FOR YOU
INSIGHT INTO EVERY FINE ENJOYMENT
STAINLESS STEEL MATERIALS,
MODERN TECHNOLOGY,
A VARIETY OF VERSATILE COLOR MATCHING



ZP-11030M

双层带板置物壁龛
规格: 宽:30.5cm 高:110cm 深:12cm
材质: 304不锈钢 1.2mm壁厚
颜色: 玫瑰金
表面处理: PVC无指纹处理
开孔尺寸: 29*108.5*12cm

Double Layer Niches With Board
Specification: Width:30.5cm Height:110cm Depth:12cm
Material:304 Stainless Steel 1.2mm Wall Thickness
Colour: Gun Gray
Surface Treatment: PVD No Fingerprint Processing
Opening Size: 29*108.5*12cm



ZP-11030H

双层带板置物壁龛
规格: 宽:30.5cm 高:110cm 深:12cm
材质: 304不锈钢 1.2mm壁厚
颜色: 黑色
表面处理: PVC无指纹处理
开孔尺寸: 29*108.5*12cm

Double Layer Niches With Board
Specification: Width:30.5cm Height:110cm Depth:12cm
Material:304 Stainless Steel 1.2mm Wall Thickness
Colour: Black
Surface Treatment: PVD No Fingerprint Processing
Opening Size: 29*108.5*12cm



ZP-11030T

双层带板置物壁龛
规格: 宽:30.5cm 高:110cm 深:12cm
材质: 304不锈钢 1.2mm壁厚
颜色: 拉丝金
表面处理: PVC无指纹处理
开孔尺寸: 29*108.5*12cm

Double Layer Niches With Board
Specification: Width:30.5cm Height:110cm Depth:12cm
Material:304 Stainless Steel 1.2mm Wall Thickness
Colour: Golden Drawbench
Surface Treatment: PVD No Fingerprint Processing
Opening Size: 29*108.5*12cm

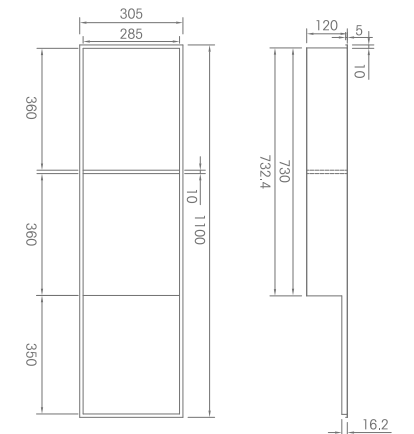

为你节省空间、创造空间
洞见每一种精臻享受
不锈钢用料、现代化工艺、多种百搭配色

SAVE SPACE AND CREATE SPACE FOR YOU
INSIGHT INTO EVERY FINE ENJOYMENT
STAINLESS STEEL MATERIALS
MODERN TECHNOLOGY
A VARIETY OF VERSATILE COLOR MATCHING

61 横单格壁龛系列
EMBEDDED NICHE SERIES



ZP-6130DG

名称: 横单格置物壁龛
产品尺寸: 610x305x120mm
开孔尺寸: 595x290x120mm
表面处理: 拉丝金

Description: Single Layer Niches
Product Size: 610x305x120mm
Opening Size: 595x290x120mm
Finishing: Brushed gold



ZP-6130DH

名称: 横单格置物壁龛
产品尺寸: 610x305x120mm
开孔尺寸: 595x290x120mm
表面处理: 拉丝枪黑

Description: Single Layer Niches
Product Size: 610x305x120mm
Opening Size: 595x290x120mm
Finishing: Brushed gun black



ZP-6130DM

名称: 横单格置物壁龛
产品尺寸: 610x305x120mm
开孔尺寸: 595x290x120mm
表面处理: 拉丝玫瑰金

Description: Single Layer Niches
Product Size: 610x305x120mm
Opening Size: 595x290x120mm
Finishing: Brushed rose gold

产品尺寸图:

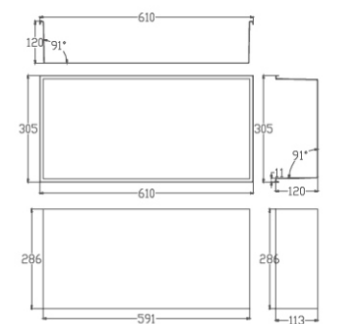

121 横长单格壁龛系列
EMBEDDED NICHE SERIES



A NEW
LIFE ARISES FROM
THE HEART REALM

bring about fun experience to the daily
life every day, and step into the realm of
mind to enjoy a new life.



ZP-12130DG

名称: 横长单格置物壁龛
产品尺寸: 1210x305x120mm
开孔尺寸: 1195x290x120mm
表面处理: 拉丝金

Description: Single Layer Niches
Product Size: 1210x305x120mm
Opening Size: 1195x290x120mm
Finishing: Brushed gold



ZP-12130DH

名称: 横长单格置物壁龛
产品尺寸: 1210x305x120mm
开孔尺寸: 1195x290x120mm
表面处理: 拉丝枪黑

Description: Single Layer Niches
Product Size: 1210x305x120mm
Opening Size: 1195x290x120mm
Finishing: Brushed gun black



ZP-12130DDG

名称: 横长单格带灯置物壁龛
产品尺寸: 1210x305x120mm
开孔尺寸: 1195x290x120mm
表面处理: 拉丝金

Description: Single Layer Niches
Product Size: 1210x305x120mm
Opening Size: 1195x290x120mm
Finishing: Brushed gold



ZP-12130DDH

名称: 横长单格带灯置物壁龛
产品尺寸: 1210x305x120mm
开孔尺寸: 1195x290x120mm
表面处理: 拉丝枪黑

Description: Single Layer Niches
Product Size: 1210x305x120mm
Opening Size: 1195x290x120mm
Finishing: Brushed gun black

产品尺寸图:





以极简主义造就更大储物
 藏匿属于你的满满小秘密
 更多颜色选择，搭配每一个生活空间

MINIMALISM FOR GREATER STORAGE
 HIDING YOUR LITTLE SECRETS
 MORE COLORS TO MATCH EVERY LIVING SPACE



ZP-3030ZJT

单层置物壁龛
 规格：宽:30.5cm 高:30.5cm 深:12cm
 材质：304不锈钢 1.2mm壁厚
 颜色：黑色
 表面处理：PVC无指纹处理
 开孔尺寸：29*29*12cm

Single Layer Niches
 Specification: Width:30.5cm Height:30.5cm Depth:12cm
 Material:304 Stainless Steel 1.2mm Wall Thickness
 Colour: Gun Gray
 Surface Treatment: PVD No Fingerprint Processing
 Opening Size: 29*29*12cm

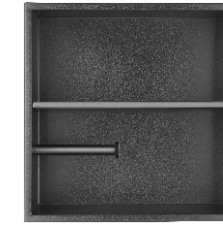

ZP-3030ZJH

单层置物壁龛
 规格：宽:30.5cm 高:30.5cm 深:12cm
 材质：304不锈钢 1.2mm壁厚
 颜色：拉丝金
 表面处理：PVC无指纹处理
 开孔尺寸：29*29*12cm

Single Layer Niches
 Specification: Width:30.5cm Height:30.5cm Depth:12cm
 Material:304 Stainless Steel 1.2mm Wall Thickness
 Colour: Golden Drawbench
 Surface Treatment: Pvd No Fingerprint Processing
 Opening Size: 29*29*12cm

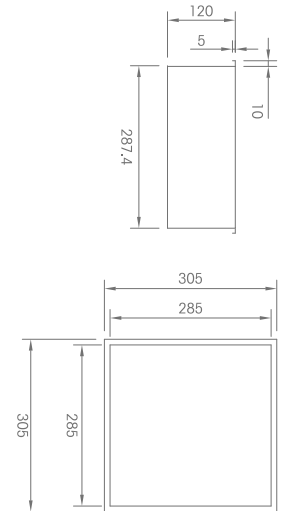

ZP-6130MTT

双层置物壁龛
 规格：宽:30.5cm 高:61cm 深:12cm
 材质：304不锈钢 1.2mm壁厚
 颜色：拉丝金
 表面处理：PVC无指纹处理
 开孔尺寸：29*59.5*12cm

Double Deck Niches
 Specification: Width:30.5cm Height:61cm Depth:12cm
 Material:304 Stainless Steel 1.2mm Wall Thickness
 Colour: Golden Drawbench
 Surface Treatment: PVD No Fingerprint Processing
 Opening Size: 29*59.5*12cm



ZP-6130MTH

双层置物壁龛
 规格：宽:30.5cm 高:61cm 深:12cm
 材质：304不锈钢 1.2mm壁厚
 颜色：黑色
 表面处理：PVC无指纹处理
 开孔尺寸：29*59.5*12cm

Double Deck Niches
 Specification: Width:30.5cm Height:61cm Depth:12cm
 Material:304 Stainless Steel 1.2mm Wall Thickness
 Colour: Black
 Surface Treatment: PVD No Fingerprint Processing
 Opening Size: 29*59.5*12cm

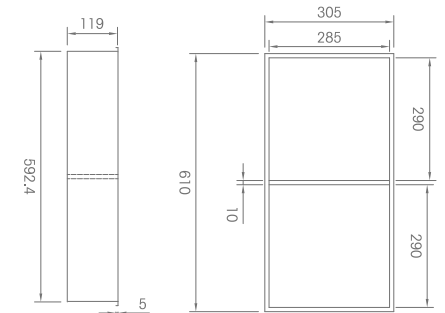



ZP-8023T

三层纸巾盒中抽置物壁龛
规格: 宽:23cm 高:80cm 深:12.5cm
材质: 304不锈钢 1.2mm壁厚
颜色: 拉丝金
表面处理: PVC无指纹处理
开孔尺寸: 22*78.5*12.5cm

Three Layers Of Paper Towel Box
Specification: Width:23cm Height:80cm Depth:12.5cm
Material:304 Stainless Steel 1.2mm Wall Thickness
Colour: Golden Drawbench
Surface Treatment: PVD No Fingerprint Processing
Opening Size: 22*78.5*12.5cm



ZP-8023H

三层纸巾盒中抽置物壁龛
规格: 宽:23cm 高:80cm 深:12.5cm
材质: 304不锈钢 1.2mm壁厚
颜色: 黑色
表面处理: PVC无指纹处理
开孔尺寸: 22*78.5*12.5cm

Three Layers Of Paper Towel Box
Specification: Width:23cm Height:80cm Depth:12.5cm
Material:304 Stainless Steel 1.2mm Wall Thickness
Colour: Black
Surface Treatment: PVD No Fingerprint Processing
Opening Size: 22*78.5*12.5cm

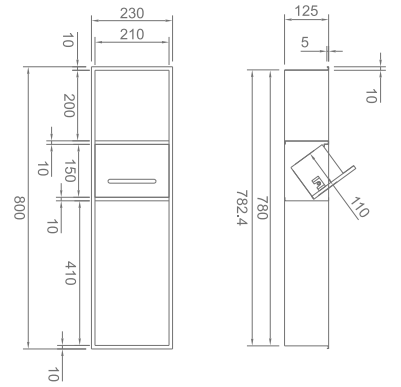

ZP-7028T

三层纸巾盒带垃圾箱壁龛
规格: 宽:28cm 高:70cm 深:13.5cm
材质: 304不锈钢 1.2mm壁厚
颜色: 拉丝金
表面处理: PVC无指纹处理
开孔尺寸: 26.5*68.5*13.5cm

Three Layer Tissue Bin Niche
Specification: Width:28cm Height:70cm Depth:13.5cm
Material:304 Stainless Steel 1.2mm Wall Thickness
Colour: Golden Drawbench
Surface Treatment: PVD No Fingerprint Processing
Opening Size: 26.5*68.5*13.5cm



ZP-7028H

三层纸巾盒带垃圾箱壁龛
规格: 宽:28cm 高:70cm 深:13.5cm
材质: 304不锈钢 1.2mm壁厚
颜色: 黑色
表面处理: PVC无指纹处理
开孔尺寸: 26.5*68.5*13.5cm

Three Layer Tissue Bin Niche
Specification: Width:28cm Height:70cm Depth:13.5cm
Material:304 Stainless Steel 1.2mm Wall Thickness
Colour: Black
Surface Treatment: PVD No Fingerprint Processing
Opening Size: 26.5*68.5*13.5cm

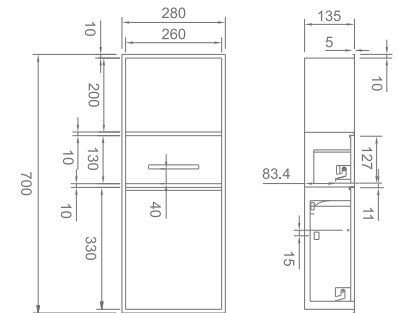



感受真实魅力

从书房到卧室、从玄关到客厅

百搭，无所不搭

多种颜色、惊艳之选

FEEL THE REAL CHARM FROM
STUDY TO BEDROOM, FROM PORCH TO LIVING ROOM
GO WITH EVERYTHING
A VARIETY OF COLORS, AMAZING CHOICE



ZP-1723T

双层纸巾盒壁龛
规格: 宽:17cm 高:23cm 深:12cm
材质: 304不锈钢 1.2mm壁厚
颜色: 拉丝金
表面处理: PVC无指纹处理
开孔尺寸: 16*21.5*12cm

Double Tissue Box Niche
Specification: Width:17cm Height:23cm Depth:12cm
Material:304 Stainless Steel 1.2mm Wall Thickness
Colour: Golden Drawbench
Surface Treatment: PVD No Fingerprint Processing
Opening Size: 16*21.5*12cm



ZP-1723H

双层纸巾盒壁龛
规格: 宽:17cm 高:23cm 深:12cm
材质: 304不锈钢 1.2mm壁厚
颜色: 黑色
表面处理: PVC无指纹处理
开孔尺寸: 15.5*21.5*12cm

Double Tissue Box Niche
Specification: Width:17cm Height:23cm Depth:12cm
Material:304 Stainless Steel 1.2mm Wall Thickness
Colour: Black
Surface Treatment: PVD No Fingerprint Processing
Opening Size: 15.5*21.5*12cm

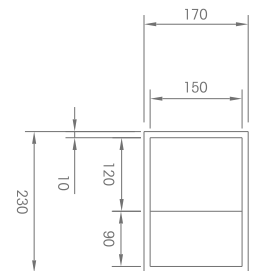
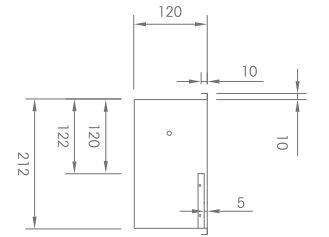

ZP-6017T

双层纸巾盒带门置物壁龛
规格: 宽:17cm 高:60cm 深:12cm
材质: 304不锈钢 1.2mm壁厚
颜色: 拉丝金
表面处理: PVC无指纹处理
开孔尺寸: 16*58.5*12cm

Double Layer Tissue Box Door Storage Niche
Specification: Width:17cm Height:60cm Depth:12cm
Material:304 Stainless Steel 1.2mm Wall Thickness
Colour: Golden Drawbench
Surface Treatment: PVD No Fingerprint Processing
Opening Size: 16*58.5*12cm



ZP-6017H

双层纸巾盒带门置物壁龛
规格: 宽:17cm 高:60cm 深:12cm
材质: 304不锈钢 1.2mm壁厚
颜色: 黑色
表面处理: PVC无指纹处理
开孔尺寸: 16*58.5*12cm

Double Layer Tissue Box Door Storage Niche
Specification: Width:17cm Height:60cm Depth:12cm
Material:304 Stainless Steel 1.2mm Wall Thickness
Colour: Black
Surface Treatment: PVD No Fingerprint Processing
Opening Size: 16*58.5*12cm

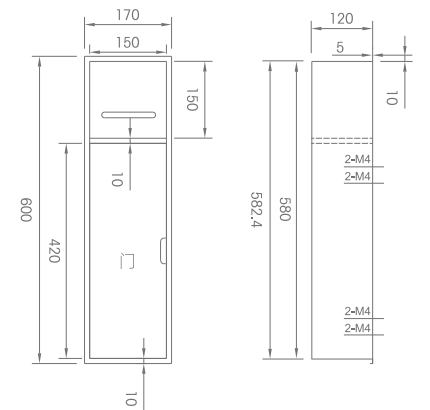



艺术盆

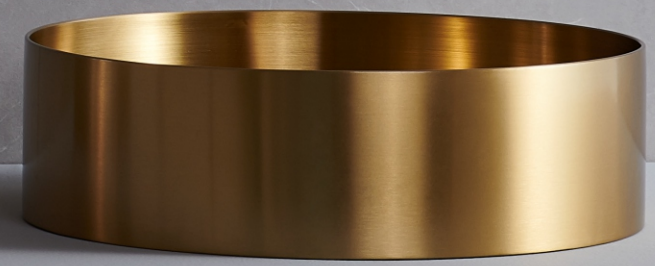
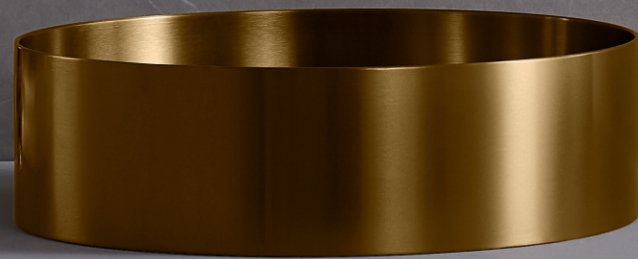



Model: 3714H



Model: 3714T



Model: 3714M



Model: 3811H



Model: 3811T



Model: 3811M



Model: 4012H



Model: 4012T



Model: 4012M



Model: 553811H

Model: 553811T



Model: 5035H

Model: 5035T

Model: 5236H

Model: 5236T



Model: 533810H

Model: 533810T

Model: 604010H

Model: 604010T

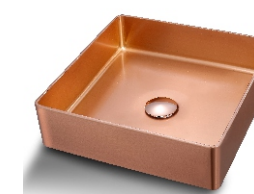

Model: 404010H

Model: 404010M

Model: 353513H

Model: 353513M

Health, fashion, kitchen
and bath expert

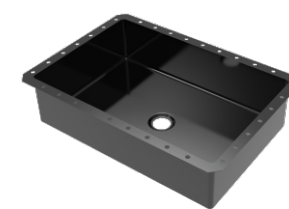

Model: 5035H

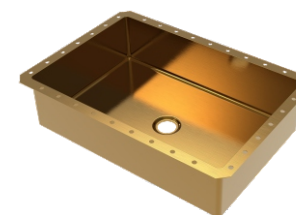

Model: 5035T

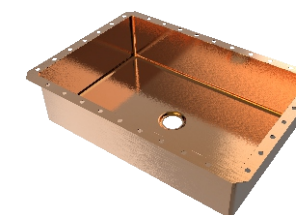

Model: 5035M



Model: 404013M



Model: 404013H



Model: 4013T

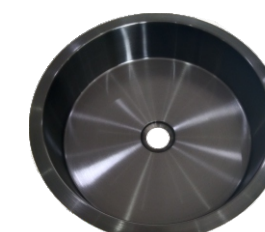

Model: 4013H

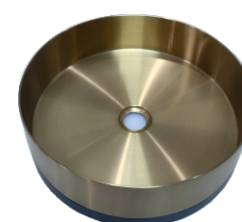

Model: 4012TH



Model: 4012HT



Model: 4011B



Model: 5535B



Model: 503510H



Model: 653811H

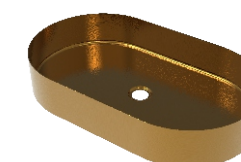

Model: 653811T

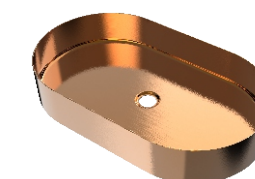

Model: 653811M

健康.时尚.厨卫洁具





Model: 3883XH



Model: 3883XHL

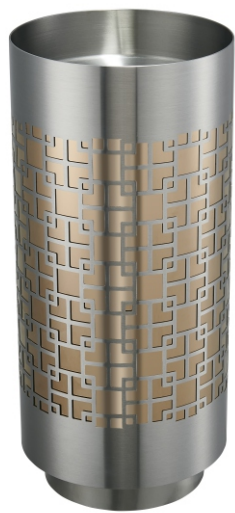

Model: 3883XM



Model: 3883XL



Model: 3883TH



Model: 3883MH



Model: 3883TQH



Model: 4283M

Model: 4283H

Model: 4283T

Model: 3883M

Model: 3883H

Model: 3883T



Model: 3843H



Model: 3838T



Model: 4043T



Model: 404083H



Model: 404083T



Model: 404083M



Model: 504283H



Model: 504283T



Model: 504283M

艺术盆

